

USER'S MANUAL

PMB-531LF

**Intel® Core Duo/Solo
Mini-ITX Motherboard
With VGA/Audio/LAN**

PMB-531LF M3

***PMB-531LF Intel® Core
Duo/Solo
Mini-ITX Motherboard
With VGA/ Sound/ LAN***

OPERATION MANUAL

COPYRIGHT NOTICE

This operation manual is meant to assist both Embedded Computer manufacturers and end users in installing and setting up the system. The information contained in this document is subject to change without any notice.

This manual is copyrighted in December, 2006. You may not reproduce or transmit in any form or by any means, electronic, or mechanical, including photocopying and recording.

ACKNOWLEDGEMENTS

All trademarks and registered trademarks mentioned herein are the property of their respective owners.

CE NOTICE

This is a class A product. In a domestic environment this product may cause radio interference in which case the user may be required to take adequate measures.

FCC NOTICE

This equipment has been tested and found to comply with the limits for a Class A digital device, pursuant to part 15 of the FCC Rules. These limits are designed to provide reasonable protection against harmful interference when the equipment is operated in a commercial environment. This equipment generates, uses, and can radiate radio frequency energy and, if not installed and used in accordance with the instruction manual, may cause harmful interference to radio communications. Operation of this equipment in a residential area is likely to cause harmful interference in which case the user will be required to correct the interference at his own expense.

You are cautioned that any change or modifications to the equipment not expressly approve by the party responsible for compliance could void your authority to operate such equipment.

TABLE OF CONTENTS

CHAPTER 1 INTRODUCTION

1-1	About This Manual	1-2
1-2	System Specification	1-3
1-3	Safety Precautions	1-6

CHAPTER 2 HARDWARE CONFIGURATION

2-1	Jumper & Connector Quick Reference Table	2-2
2-2	Component Locations	2-3
2-3	How to Set the Jumpers	2-4
2-4	COM Port Connector	2-6
2-5	COM3/4 RI& Voltage Selection	2-8
2-6	RS232/422/485(COM2) Selection	2-10
2-7	Keyboard and PS/2 Mouse Connector	2-11
2-8	Reset Connector	2-11
2-9	Hard Disk Drive LED Connector	2-12
2-10	ATX Power Button	2-12
2-11	External Speaker Connector	2-12
2-12	PLed Connector	2-13
2-13	Clear CMOS Data Selection	2-13
2-14	CPU Fan Connector	2-14
2-15	System Fan Connector	2-14
2-16	Hard Disk Drive Connector	2-15
2-17	VGA Connector	2-16
2-18	Serial ATA Connector	2-17
2-19	Universal Serial Bus Connector	2-18
2-20	USB & LAN Connector	2-19
2-21	IrDA Connector	2-20
2-22	ATX Power Connector	2-20
2-23	Sound Connector	2-21
2-24	CD Audio-In Connector	2-22
2-25	LVDS Connector	2-22
2-26	Inverter Connector	2-23
2-27	LVDS Panel Voltage Selection	2-23
2-28	FSB Frequency Selection	2-24
2-29	Power State Selection	2-25
2-30	Reset/NMI Watchdog Selection	2-26
2-31	CF Card Master/ Slave Selection	2-27
2-32	TV Out Connector	2-28
2-33	Memory Installation	2-28

CHAPTER 3 SOFTWARE UTILITIES

3-1	Introduction	3-2
3-2	VGA Driver Utility	3-3
3-3	Flash BIOS Update	3-4
3-4	LAN Driver Utility	3-6
3-5	Sound Driver Utility	3-7
3-6	Intel Chipset Software Installation Utility	3-8
3-7	USB2.0 Software Installation Utility	3-9
3-8	RAID Software Installation Utility	3-10
3-8	Watchdog Timer Configuration	3-11

CHAPTER 4 AWARD BIOS SETUP

4-1	Introduction	4-2
4-2	Entering Setup	4-3
4-3	The Standard CMOS Features	4-4
4-4	The Advanced BIOS Features	4-8
4-5	Advanced Chipset Features	4-11
4-6	Integrated Peripherals	4-14
4-7	Power Management Setup	4-19
4-8	PNP/PCI Configuration	4-20
4-9	PC Health Status	4-22
4-10	Load Fail-Safe Defaults	4-23
4-11	Load Optimized Defaults	4-23
4-12	Password Setting	4-24
4-13	Save & Exit Setup	4-25
4-14	Exit Without Saving	4-26

APPENDIX A EXPANSION BUS

Mini PCI Bus Pin Assignment	A-2
Compact Flash Card Connector Pin Assignment	A-4

APPENDIX B TECHNICAL SUMMARY

Block Diagram	B-2
Interrupt Map	B-3
RTC & CMOS RAM Map	B-4
Timer & DMA Channels Map	B-5
I/O & Memory Map	B-6

INTRODUCTION

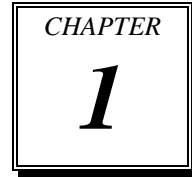

This chapter gives you the information for PMB-531LF. It also outlines the System specifications.

Section includes:

- About This Manual
- System Specifications
- Safety Precautions

Experienced users can skip to chapter 2 on page 2-1 for a Quick Start.

1-1. ABOUT THIS MANUAL

Thank you for purchasing our PMB-531LF Intel® Core Duo/Solo Mainboard enhanced with VGA/Sound/LAN, which is fully PC / AT compatible. The PMB-531LF provides faster processing speed, greater expandability and can handle more tasks than before. This manual is designed to assist you how to install and set up the system. It contains four chapters. The user can apply this manual for configuration according to the following chapters:

Chapter 1 Introduction

This chapter introduces you to the background of this manual, and the specifications for this system. The final page of this chapter will indicate how to avoid damaging this board.

Chapter 2 Hardware Configuration

This chapter outlines the component locations and their functions. In the end of this chapter, you will learn how to set jumper and how to configure this card to meet your own needs.

Chapter 3 Software Utilities

This chapter contains helpful information for proper installations of the VGA utility, LAN utility, Sound utility, and Flash BIOS Update. It also describes the Watchdog-timer configuration.

Chapter 4 Award BIOS Setup

This chapter indicates you how to set up the BIOS configurations.

Appendix A Expansion Bus

This Appendix introduces you the expansion bus for PCI-E x16 BUS.

Appendix B Technical Summary

This section gives you the information about the Technical maps.

1-2. SYSTEM SPECIFICATIONS

- **CPU:**

- Intel® Core Duo up to 2.33GHz.
- Intel® Core Solo up to 1.83GHz.
- Intel® Core Duo ULV up to 1.2 GHz.
- Intel® Core Solo ULV up to 1.2 GHz.
- Auto detect voltage regulator.

- **CHIPSET:**

- Intel® 945GM + ICH7R (FSB: 533/667MHz)

- **MEMORY :**

- 2 x 200-pin DDR2 SO-DIMM
- Support DDR II 667 SDRAM up to 2GB.

- **CACHE :**

- Built-in CPU.

- **REAL-TIME CLOCK :**

- 256-byte battery backed CMOS RAM.
- Hardware implementation to indicate century rollover.

- **BIOS :**

- Phoenix-AwardBIOS™ for plug & play function.
- 4/8MB with VGA BIOS.
- Easy update 512KB flash EEPROM.
- Support S/IO Setup.

- **KEYBOARD CONNECTOR :**

- Mini DIN connector.
- Supports for AT/PS2 keyboard.

- **MOUSE CONNECTOR :**

- Mini DIN connector.
- Supports for PS/2 Mouse.

- **BUS SUPPORT :**

- 1 PCI-E (x16) Slot (SDVO), Mini-PCI, CF (only available if no IDE device attached)

● **DISPLAY :**

Built-in Intel 945GM, support for CRT, LVDS, TV-Out.
Onboard 15-pin VGA D-SUB connector, support for resolution on QXGA Monitor.

● **IDE INTERFACE :**

One IDE ports support up to two IDE devices.
Supports Ultra DMA 33.

● **SERIAL ATA PORT :**

Two S-ATA connectors from ICH7R.

● **USB CONNECTOR :**

Support up to six USB 2.0 ports.

● **LAN ADAPTER :**

LAN: Intel® 82573V (10/100/1000 Mbps)
Support wake-on-LAN function.

● **SERIAL PORT :**

Four high speed 16550 Compatible UARTs with Send / Receive 16 Byte FIFOs; COM1/3/4:RS-232; COM2: RS-232/422/485
MIDI Compatible
Programmable Baud Rate Generator

● **SOUND :**

Realtek ALC655 (AC'97 Codec).
Fully Compliant AC'97 Analog I/O Component
16-Bit Stereo Full-Duplex Codec
Four Analog Line-level Stereo Inputs for Connection.
High Quality CD Input with Ground Sense
Stereo Line-Level Output
Interface: Line-In, Line-Out, Microphone, and CD Audio-In.

● **HARDWARE MONITORING FUNCTION :**

Monitor Voltage, CPU temperature, & Cooling fan speed.
If CPU Temperature is over setting, the buzzer will send out a warning (only under DOS system).

- **IRDA PORT :**
5-pin Infrared port, support IrDA v1.0 SIR protocol
- **GREEN FUNCTION :**
Controlled by hardware and software.
- **LED INDICATOR :**
System power
Hard Disk access
LAN LED indicator
- **DMA CONTROLLER :**
8237 x 2
- **DMA CHANNELS :**
7
- **INTERRUPT CONTROLLERS :**
82C59 x 2
- **INTERRUPT LEVELS :**
15
- **OPERATING TEMPERATURE :**
0 to 60°C.
- **BOARD DIMENSIONS :**
170 mm x 170 mm, 6.69" x 6.69"
- **BOARD NET WEIGHT :**
810 gram.

1-3. SAFETY PRECAUTIONS

Follow the messages below to avoid your systems from damage:

1. Keep your system away from static electricity on all occasions.
2. Prevent electric shock. Don't touch any components of this card when the card is power-on. Always disconnect power when the system is not in use.
3. Disconnect power when you change any hardware devices. For instance, when you connect a jumper or install any cards, a surge of power may damage the electronic components or the whole system.

HARDWARE CONFIGURATION

CHAPTER

2

**** *QUICK START* ****

Helpful information describes the jumper & connector settings, and component locations.

Section includes:

- Jumper & Connector Quick Reference Table
- Component Locations
- Configuration and Jumper settings
- Connector's Pin Assignments

2-1. JUMPER & CONNECTOR QUICK REFERENCE TABLE

COM Port Connector	COM1,COM2,COM3,COM4
COM3/4 Port RI/Voltage Selection	JP16,JP17
RS232/422/485 (COM2) Selection	JP15
Keyboard/Mouse Connector	JKBMS1
Reset Connector	JPANEL1 (13 , 15)
Hard Disk Drive LED Connector	JPANEL1 (09 , 11)
Power Button	JPANEL1 (14 , 16)
External Speaker Connector	JPANEL1 (1 , 3 , 5 , 7)
Power LED Connector	JPANEL1 (08 , 10 , 12)
Clear CMOS Data Selection	JP2
CPU Fan Connector	FAN1
System Fan Connector	FAN2, JCFAN1
Hard Disk Drive Connector	IDE1
VGA Connector	VGA1
Serial ATA Connector	SATA1,SATA2
Universal Serial Bus Connector	USB1, USB2
USB & LAN Connector	J2
IRDA Connector	IRDA1
ATX Power Connector	PW1, JATXPWR2
Sound Connector	JAUDIO1
CD Audio-In Connector	JCDIN1
LVDS Connector	J1
Inverter Connector	J4
LVDS Panel Voltage Selection	JP4
FSB Frequency Selection	JP5 , JP6 , JP7
Power State Selection	JP21(1-2), JP22
Reset/NMI Watchdog Selection	JP21
CF Card Master/ Slave Selection	JP14
TV Out Connector	JP1
Memory Installation	DIM1, DIM2

2-2. COMPONENT LOCATIONS

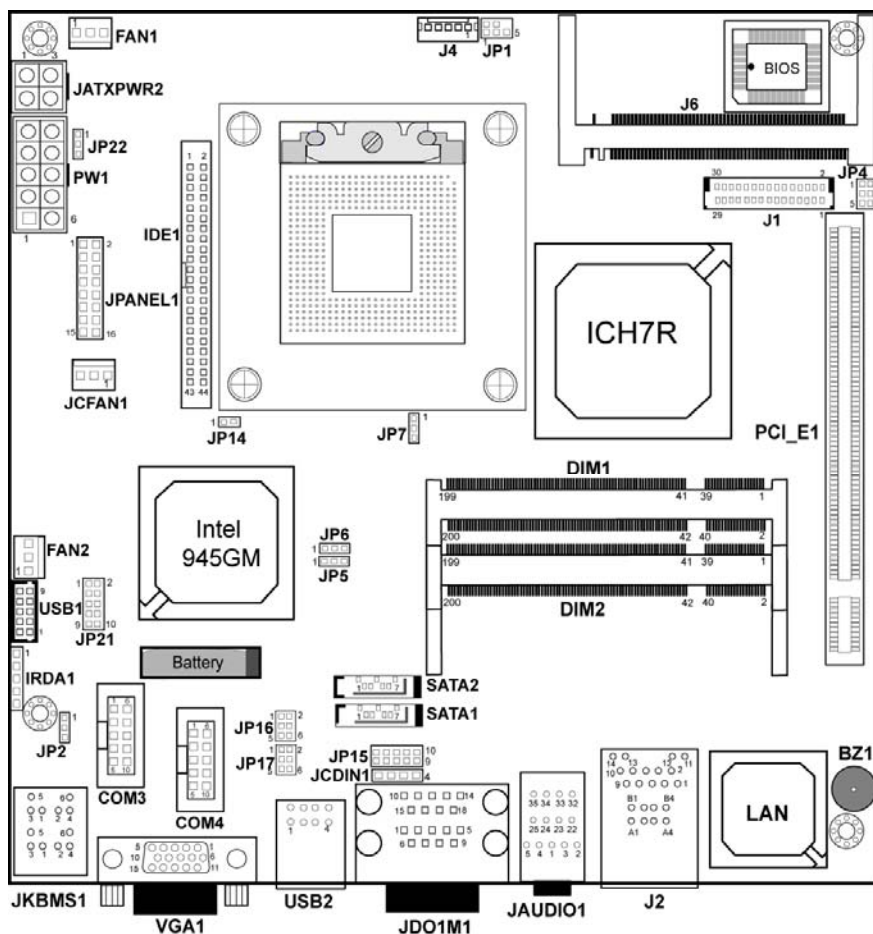

PMB-531LF Connector, Jumper and Component locations

2-3. HOW TO SET THE JUMPERS

You can configure your board by setting jumpers. Jumper is consists of two or three metal pins with a plastic base mounted on the card, and by using a small plastic "cap", Also known as the jumper cap (with a metal contact inside), you are able to connect the pins. So you can set-up your hardware configuration by "open" or "close" pins.

The jumper can be combined into sets that called jumper blocks. When the jumpers are all in the block, you have to put them together to set up the hardware configuration. The figure below shows how this looks like.

JUMPERS AND CAPS

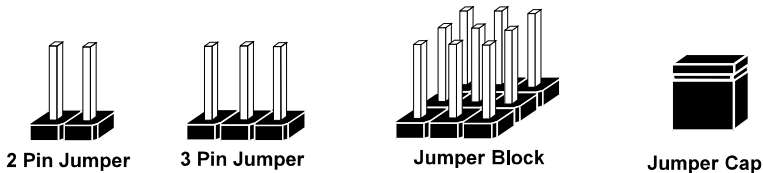

If a jumper has three pins (for examples, labelled PIN1, PIN2, and PIN3), You can connect PIN1 & PIN2 to create one setting by shorting. You can either connect PIN2 & PIN3 to create another setting. The same jumper diagrams are applied all through this manual. The figure below shows what the manual diagrams look and what they represent.

JUMPER DIAGRAMS



Jumper Cap
looks like this



2 pin Jumper
looks like this

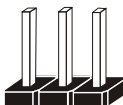

3 pin Jumper
looks like this

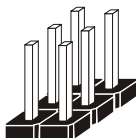

Jumper Block
looks like this

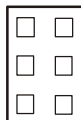

JUMPER SETTINGS



2 pin Jumper close(enabled)
Looks like this



1

1



3 pin Jumper
2-3 pin close(enabled)
Looks like this



1

1



Jumper Block
1-2 pin close(enabled)
Looks like this

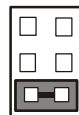

1 2

1 2

2-4. COM PORT CONNECTOR

COM1 : COM1 Connector

COM1 is fixed as RS-232.

The pin assignment is as follows :

PIN	ASSIGNMENT
1	DCD1
2	RX1
3	TX1
4	DTR1
5	GND
6	DSR1
7	RTS1
8	CTS1
9	RI1

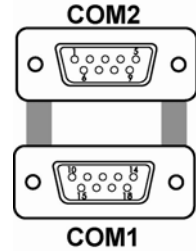

COM2 : COM2 Connector

The COM2 is selectable as RS-232/422/485.

The pin assignment is as follows :

PIN	ASSIGNMENT		
	RS-232	RS-422	RS-485
1	DCD2	TX-	TX-
2	RX2	TX+	TX+
3	TX2	RX+	RX+
4	DTR2	RX-	RX-
5	GND	GND	GND
6	DSR2	RTS-	NC
7	RTS2	RTS+	NC
8	CTS2	CTS+	NC
9	RI2	CTS-	NC

COM3 : COM3 Connector

COM3 is fixed as RS-232.

The pin assignment is as follows :

PIN	ASSIGNMENT
1	DCD3
2	RX3
3	TX3
4	DTR3
5	GND
6	DSR3
7	RTS3
8	CTS3
9	RI3
10	NC

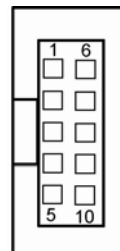

COM3

 COM3's pin 9 is selectable for RI, +5V or +12V. For more information, please refer to our "2-5 COM RI and Voltage Selection".

COM4 : COM4 Connector

COM4 is fixed as RS-232.

The pin assignment is as follows :

PIN	ASSIGNMENT
1	DCD4
2	RX4
3	TX4
4	DTR4
5	GND
6	DSR4
7	RTS4
8	CTS4
9	RI4
10	NC

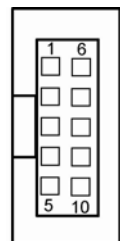

COM4

 COM4's pin 9 is selectable for RI, +5V or +12V. For more information, please refer to our "2-5 COM RI and Voltage Selection".

2-5. COM3/4 RI & VOLTAGE SELECTION

JP16 : COM3 RI & Voltage Selection

The selections are as follows:

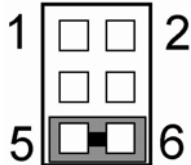
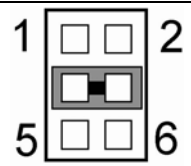
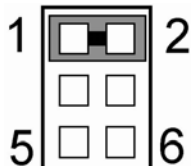
COM	SELECTION	JUMPER SETTINGS	JUMPER ILLUSTRATION
COM3	5V	5-6	 <p>JP16</p>
	12V	3-4	 <p>JP16</p>
	RI	1-2	 <p>JP16</p>

***Manufacturing Default -- RI.

JP17 : COM4 RI & Voltage Selection

The selections are as follows:

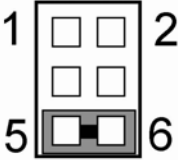
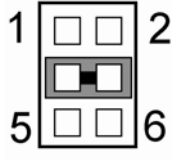
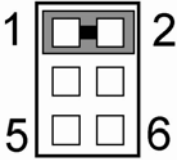
COM	SELECTION	JUMPER SETTINGS	JUMPER ILLUSTRATION
COM4	5V	5-6	 <p>JP17</p>
	12V	3-4	 <p>JP17</p>
	RI	1-2	 <p>JP17</p>

***Manufacturing Default -- RI.

2-6. RS232/422/485 (COM2) SELECTION

JP15 : RS-232/422/485 (COM2) Selection

This connector is used to set the COM2 function.

The jumper settings are as follows :

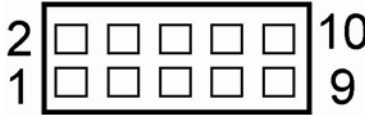
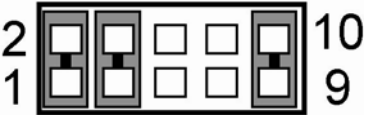
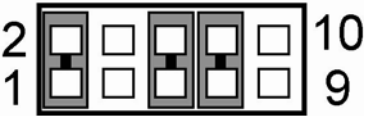
COM 2 Function	Jumper Settings (pin closed)	Jumper Illustrations
RS-232	All Open	 <p style="text-align: center;">JP15</p>
RS-422	1-2, 3-4, 9-10	 <p style="text-align: center;">JP15</p>
RS-485	1-2, 5-6, 7-8	 <p style="text-align: center;">JP15</p>

*** Manufacturing default -- RS-232.

2-7. PS/2 KEYBOARD AND MOUSE CONNECTOR

JKBMS1 : PS/2 Keyboard and Mouse Connector

The pin assignments are as follows :

PIN	ASSIGNMENT
1	KBDATA
2	NC
3	GND
4	5VSB
5	KBCLK
6	NC
7	MSDATA
8	NC
9	GND
10	5VSB
11	MSCLK
12	NC

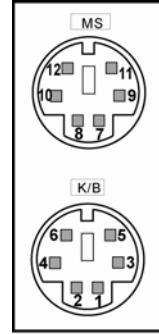

JKBMS1

2-8. RESET CONNECTOR

JPANEL1 (13, 15) : Reset Connector.

The pin assignment is as follows :

PIN	ASSIGNMENT
13	GND
15	RST_BTN

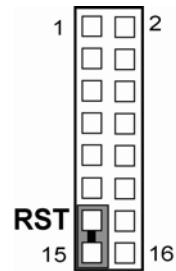

JPANEL1

2-9. HARD DISK DRIVE LED CONNECTOR

JANEL1 (9, 11) : Hard Disk Drive LED Connector
 The pin assignment is as follows :

PIN	ASSIGNMENT
9	HD_LED+
11	HD_LED-

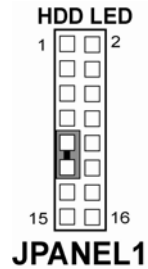

2-10. ATX POWER BUTTON

JANEL1 (14, 16) : ATX Power Button
 The pin assignment is as follows :

PIN	ASSIGNMENT
14	PW_BN1
16	PW_BN2

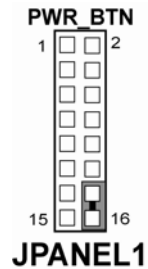

2-11. EXTERNAL SPEAKER CONNECTOR

JANEL1 (1, 3, 5, 7) : External Speaker Connector
 The pin assignment is as follows :

PIN	ASSIGNMENT
1	P_SPK
3	NC
5	NC
7	VCC

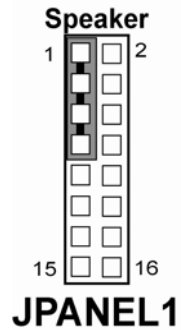

2-12. POWER LED CONNECTOR

JPANEL1 (8, 10, 12) : Power LED Connector

The pin assignment is as follows:

PIN	ASSIGNMENT
8	PW_LED+
10	PW_LED+
12	PW_LED-

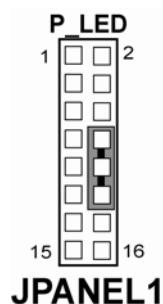

2-13. CLEAR CMOS DATA SELECTION

JP2 : Clear CMOS Data Selection

The selections are as follows :

FUNCTION	JUMPER SETTING (pin closed)	JUMPER ILLUSTRATION
Keep CMOS	1-2	 JP2
Clear CMOS	2-3	 JP2

*** Manufacturing Default – Keep CMOS.

Note: To clear CMOS data, user must power-off the computer and set the jumper to “Clear CMOS” as illustrated above. After five to six seconds, set the jumper back to “Normal” and power-on the computer.

2-14. CPU FAN CONNECTOR

FAN1 : CPU Fan connector
The pin assignment is as follows:

PIN	ASSIGNMENT
1	LPC1_FANPWM1
2	+12V
3	LPC1_FANIO1

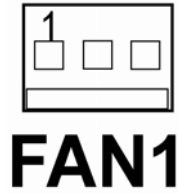

2-15. SYSTEM FAN CONNECTOR

FAN2 : System Fan connector
The pin assignment is as follows :

PIN	ASSIGNMENT
1	LPC1_FANPWM2
2	+12V
3	LPC1_FANIO2



JCFAN1 : System Fan connector
The pin assignment is as follows :

PIN	ASSIGNMENT
1	GND
2	+12V
3	NC



2-16. HARD DISK DRIVE CONNECTOR

The PMB-531LF possesses one HDD connector: IDE1.

IDE1: Hard Disk Drive Connector

The pin assignments are as follows:

PIN	ASSIGNMENT	PIN	ASSIGNMENT
1	IDERST	2	GND
3	PDD7	4	PDD8
5	PDD6	6	PDD9
7	PDD5	8	PDD10
9	PDD4	10	PDD11
11	PDD3	12	PDD12
13	PDD2	14	PDD13
15	PDD1	16	PDD14
17	PDD0	18	PDD15
19	GND	20	NC
21	PDREQ	22	GND
23	PDIOW#	24	GND
25	PDIOR#	26	GND
27	PIORDY	28	PD_CSEL
29	PDDACK#	30	GND
31	IRQ14	32	NC
33	PDA1	34	P66 DETECT
35	PDA0	36	PDA2
37	PDCS1#	38	PDCS3#
39	IDEACTN	40	GND
41	VCC	42	VCC
43	GND	44	GND



IDE1

2-17. VGA CONNECTOR

VGA1: VGA Connector

The pin assignments are as follows:

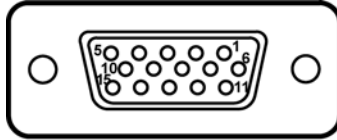

VGA1

PIN	ASSIGNMENT
1	RED
2	GREEN
3	BLUE
4	NC
5	GND
6	GND
7	GND
8	GND
9	VCC
10	GND
11	NC
12	VGA IIC DATA
13	HSYNC
14	VSYNC
15	VGA IIC CLK

2-18. SERIAL ATA CONNECTOR

SATA1~SATA2: The PMB-531LF possesses two Serial ATA Connector, SATA1~SATA2. The pin assignments are as follows:

SATA1 : SATA Connector

The pin assignments are as follows :

PIN	ASSIGNMENT
1	GND
2	SATA_TXP0
3	SATA_TXN0
4	GND
5	SATA_RXN0
6	SATA_RXP0
7	GND



SATA2 : SATA Connector

The pin assignments are as follows :

PIN	ASSIGNMENT
1	GND
2	SATA_TXP1
3	SATA_TXN1
4	GND
5	SATA_RXN1
6	SATA_RXP1
7	GND



2-19. UNIVERSAL SERIAL BUS CONNECTOR

USB1 : Universal Serial Bus Connector

The pin assignments are as follows :

PIN	ASSIGNMENT
1	VCCUSB2
2	VCCUSB2
3	USB4N
4	USB5N
5	USB4P
6	USB5P
7	GND
8	GND
9	GND
10	GND

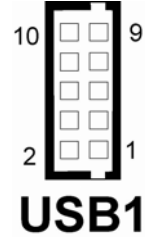

JUSB2 : Universal Serial Bus Connector

The pin assignments are as follows :

PIN	ASSIGNMENT
A1	VCCUSB1
A2	USB0N
A3	USB0P
A4	GND
B1	VCCUSB1
B2	USB1N
B3	USB1P
B4	GND

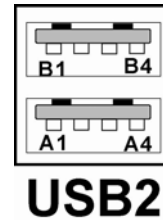

2-20. USB&LAN CONNECTOR

J2 : USB & LAN Connector

The pin assignments are as follows :

LAN:

PIN	ASSIGNMENT
1	MDI_0P
2	MDI_0N
3	MDI_1P
4	MDI_1N
5	MDI_2P
6	MDI_2N
7	MDI_3P
8	MDI_3N

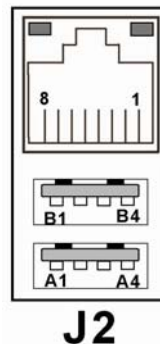

LAN LED Indicator:

Left side LED:

Green Color on	10/100 LAN Speed Indicator
Orange Color on	Giga LAN Speed Indicator
off	No LAN switch/hub connected

Right side LED:

Yellow Color Blinking	LAN Message Active
off	No LAN Message Active

USB Signal :

PIN	ASSIGNMENT
A1	VCCUSB0
A2	USB2N
A3	USB2P
A4	GND
B1	VCCUSB0
B2	USB3N
B3	USB3P
B4	GND

2-21. IRDA CONNECTOR

IRDA1: IrDA (Infrared) Connector
The pin assignments are as follows:

PIN	ASSIGNMENT
1	+5V
2	NC
3	IRRX
4	GND
5	IRTX

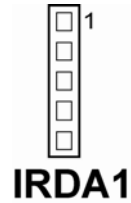

2-22. ATX POWER CONNECTOR

PW1 : ATX 12V Connector
The pin assignments are as follows :

PIN	ASSIGNMENT
1	VCC
2	VCC
3	GND
4	GND
5	+12V
6	+5V SB
7	VCC
8	GND
9	PS_ON
10	NC

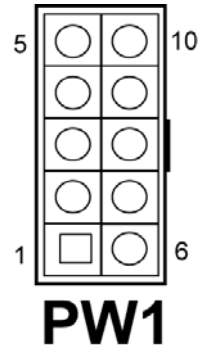

ATXPWR2 : ATX Connector

The pin assignments are as follows :

PIN	ASSIGNMENT
1	GND
2	GND
3	+12V
4	+12V

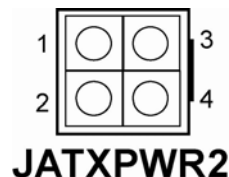

2-23. SOUND CONNECTOR

JAUDIO1 : Sound Connector

The pin assignments are as follows :

SPDIF (inside the Line-In hole)

PIN	ASSIGNMENT
42	GND
43	VCC
44	AC_SPDIF0

Line-In: light blue color

PIN	ASSIGNMENT
32	LINE_L
35	LINE_R

SPK-Out: light green color

PIN	ASSIGNMENT
22	SPK_L
25	SPK_R

Mic-In: pink color

PIN	ASSIGNMENT
1	GND
2	MIC_IN1
5	MIC_IN2

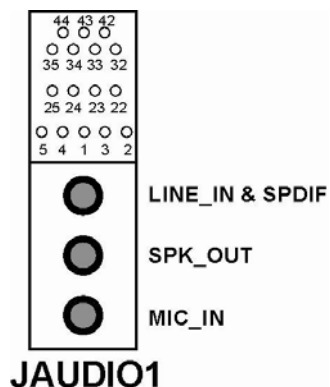

2-24. AUDIO CD-IN CONNECTOR

JCDIN1 : Audio CD-In Connector

The pin assignments are as follows :



PIN	ASSIGNMENT
1	CD L
2	CDGND
3	CDGND
4	CD R

2-25. LVDS CONNECTOR

J1 : LVDS CONNECTOR

The pin assignments are as follows :

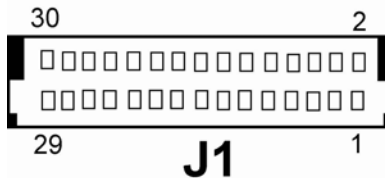

PIN	ASSIGNMENT	PIN	ASSIGNMENT
1	LVDS_VCC	2	GND
3	CLKBM	4	CLKBP
5	GND	6	YBM2
7	YBP2	8	GND
9	YBM1	10	YBP1
11	NC	12	NC
13	YBP0	14	YBM0
15	GND	16	CLKAP
17	CLKAM	18	GND
19	YAP2	20	YAM2
21	GND	22	YAP1
23	YAM1	24	GND
25	YAP0	26	YAM0
27	NC	28	NC
29	LVDS_VCC	30	LVDS_VCC

2-26. INVERTER CONNECTOR

J4 : LVDS Panel Voltage Selection.

The pin assignments are as follows :

PIN	ASSIGNMENT
1	+12V
2	GND
3	VCC
4	GND
5	ENABKL (Inverter backlight ON/OFF control signal)

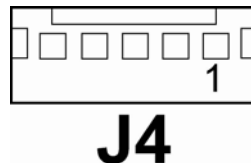

2-27. LVDS PANEL VOLTAGE SELECTION

JP4 : LVDS Panel Voltage Selection.

The pin assignments are as follows :

SELECTION	JUMPER SETTING (pin closed)	JUMPER ILLUSTRATION
+3.3V	1-3 2-4	<p>The diagram shows a 6-pin header connector labeled JP4. Pins 1 and 2 are at the top, and pins 5 and 6 are at the bottom. Jumpers are shown connecting pins 1 to 3 and pins 2 to 4.</p>
+5V	3-5 4-6	<p>The diagram shows a 6-pin header connector labeled JP4. Pins 1 and 2 are at the top, and pins 5 and 6 are at the bottom. Jumpers are shown connecting pins 3 to 5 and pins 4 to 6.</p>

*** Manufacturing Default – +3.3V.

2-28. FSB FREQUENCY SELECTION

JP5, JP6, JP7 : FSB Frequency Selections.

The pin assignments are as follows :

SELECTION	JUMPER SETTING (pin closed)			JUMPER ILLUSTRATION
	JP5	JP6	JP7	
533 MHz	2-3	2-3	2-3	
667 MHz	2-3	open	2-3	

*** Manufacturing Default – 667 MHz.

2-29. POWER STATE SELECTION

JP21(1-2), JP22 : Power State Selections.

The pin assignments are as follows :

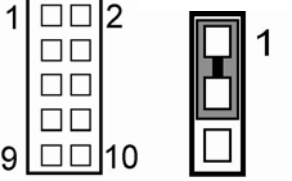
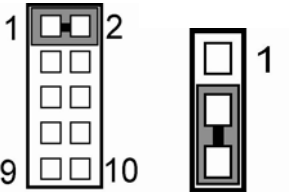
Selections	Jumper Setting	Jumper Illustrations
ATX	JP21 (Open) JP22 (1-2)	 <p>JP21 JP22</p>
AT	JP21 (1-2) JP22 (2-3)	 <p>JP21 JP22</p>

*** Manufacturing Default – ATX.

2-30. RESET/ NMI SELECTIONS

JP21 : Reset/ NMI Selections.

The pin assignments are as follows :

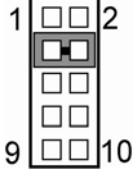
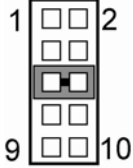
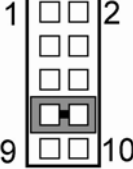
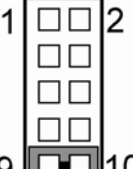

Selections	Jumper Setting	Jumper Illustration
RESET	3-4 CLOSE	 <p>JP21</p>
NMI	5-6 CLOSE	 <p>JP21</p>
CLEAR WDG	7-8 CLOSE	 <p>JP21</p>
GPIO For Customer Application	9-10	 <p>JP21</p>

*** Manufacturing Default – Reset.

2-31. CF CARD MASTER/SLAVE SELECTIONS

JP14 : CF Card Master/ Slave Selection.

The pin assignments are as follows :

Selections	Jumper Setting	Jumper Illustration
Master	Close	1  JP14
Slave	Open	1  JP14

*** Manufacturing Default – Slave.

2-32. TV OUT CONNECTOR

JP1 : TV OUT CONNECTOR

The pin assignments are as follows :

PIN	ASSIGNMENT
1	Luminance(Y)
2	CVBS
3	GND
4	GND
5	Chrominance(UV)

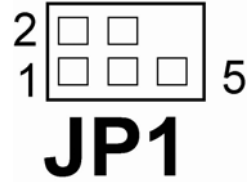

2-33. MEMORY INSTALLATION

PMB-531LF CPU Card can support up to 1GB in one SODIMM sockets.

DRAM BANK CONFIGURATION

DIMM1	DIMM2	Total memory size
256 MB	256 MB	512 MB
512 MB	512 MB	1GB
1GB	1GB	2GB

SOFTWARE UTILITIES

CHAPTER

3

This chapter comprises the detailed information of VGA driver, LAN driver, and Flash BIOS update. It also describes how to install the watchdog timer configuration.

Section includes:

- VGA Driver Utility
- Flash BIOS Update
- LAN Driver Utility
- Sound Driver Utility
- Intel® Chipset Software Installation Utility
- USB2.0 Chipset Software Installation Utility
- RAID Software Installation Utility
- Watchdog Timer Configuration

3-1. INTRODUCTION

Enclosed with our PMB-531LF package is our driver utility, which may come in a form of a CD ROM disc or floppy diskettes. For CD ROM disc user, you will only need some of the files contained in the CD ROM disc, please kindly refer to the following chart:

Filename (Assume that CD ROM drive is D:)	Purpose
D:\Driver\VGA	Intel 945GM For VGA driver installation
D:\Driver\FLASH	For BIOS update utility
D:\Driver\LAN	For LAN Driver installation
D:\Driver\Sound	Realtek ALC655 AC97 For Sound driver installation
D:\Driver\UTILITY	Intel® Chipset Software Installation Utility For Win 2000, XP, Server2003
D:\Driver\USB 2.0	USB 2.0 Software Installation Utility For Win 2000, XP
D:\Driver\F6f1PY32	For RAID driver disk installation in F6
D:\Driver\RAID	RAID software and driver. The RAID controller management for windows 2000, XP, server 2003

⚠ User should remember to install the Utility right after the OS fully installed.

3-2. VGA DRIVER UTILITY

The VGA interface embedded with our PMB-531LF can support a wide range of display. You can display CRT, PCI-E (SDVO) simultaneously with the same mode.

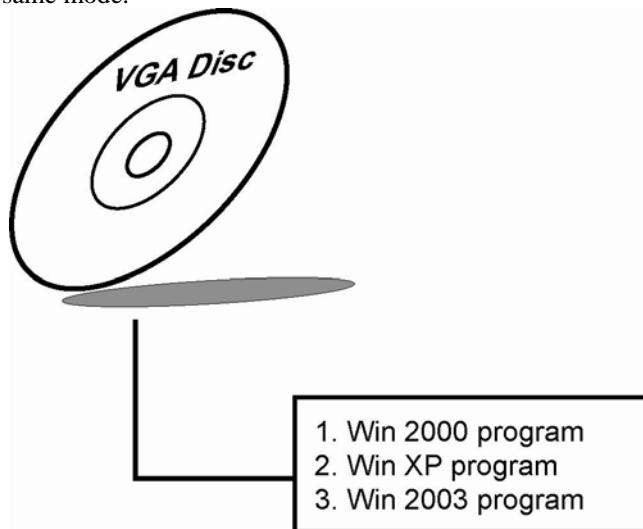

3-2-1. Installation of VGA Driver:

To install the VGA Driver, simply follow the following steps:

1. Place insert the Utility Disk into Floppy Disk Drive A/B or CD ROM drive.
2. Under Windows 2000/XP/2003 system, go to the directory where VGA driver is located.
3. Click **Setup.exe** file for VGA driver installation.
4. Follow the instructions on the screen to complete the installation.
5. Once installation is completed, shut down the system and restart in order for the changes to take effect.

3-3. FLASH BIOS UPDATE

3-3-1. System BIOS Update:

Users of PMB-531LF can use the program “Awdflash.exe” contained in the Utility Disk for system BIOS and VGA BIOS update.

3-3-2. To update VGA BIOS for LCD Flat Panel Display:

As PMB-531LF user, you have to update the VGA BIOS for your specific LCD flat panel you are going to use. For doing this, you need two files. One is the “Awdflash.exe” file and the other is the VGA BIOS for ATI Rage Mobility M6 file for LCD panel display. Both file must be provided by the vendor or manufacturer. When you get these two files ready, follow the following steps for updating your VGA BIOS:

1. Install “Awdflash.exe” from Utility Disk to Drive C.
2. Insert the VGA BIOS file you have obtained from the vendor.
Type the path to Awdflash.exe and execute the VGA BIOS update with file B531xxxx.bin
3. C:\UTIL\AWDFLASH>AWDFLASH B531xxxx.bin
4. The screen will display as the table found on the next page:

FLASH MEMORY WRITER v7.XX (C) Award Software 2001 All Rights Reserved
Flash Type – SST 49LF004A /3.3V File Name to Program: B531xxxx.bin Checksum: XXXXX
Error Message: Do You Want To Save BIOS (Y/N)

If you want to save up the original BIOS, enter "Y" and press < Enter >. If you choose "N", the following table will appear on screen.

FLASH MEMORY WRITER v7.XX (C) Award Software 2001 All Rights Reserved
Flash Type – SST 49LF004A /3.3V File Name to Program: B531xxxx.bin Checksum: XXXXX
Error Message : Are You Sure To Program (Y/N)

Select "Y", and the BIOS will be renewed. When you are refreshing the BIOS, do not turn off or reset the system, or you will damage the BIOS. After you have completed all the programming, the screen displays the table below:

FLASH MEMORY WRITER v7.XX (C) Award Software 2001 All Rights Reserved
Flash Type – SST 49LF004A /3.3V File Name to Program: B531xxxx.bin Checksum: XXXXX Reset System or Power off to accomplish update process!
F1: Reset F10: Exit

Please reset or power off the system, and then the Flash BIOS is fully implemented.

3-4. LAN DRIVER UTILITY

3-4-1. Introduction

PMB-531LF is enhanced with LAN function that can support various network adapters. Installation programs for LAN drivers are listed as follows:

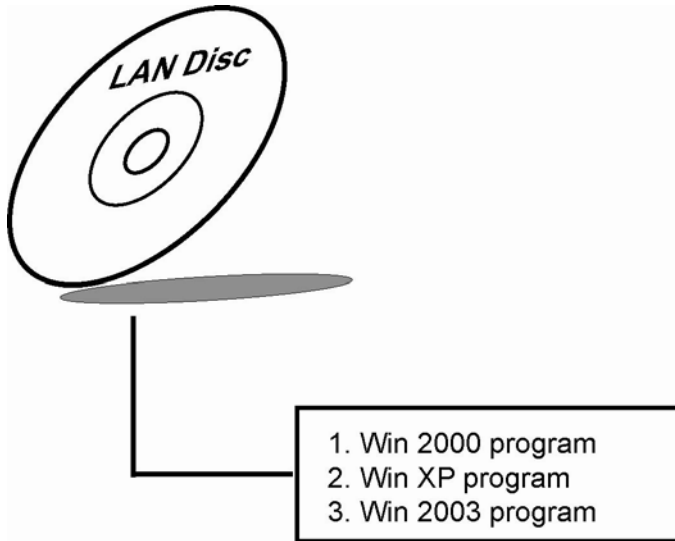

For more details on Installation procedure, please refer to Readme.txt file found on LAN DRIVER UTILITY.

3-5. SOUND DRIVER UTILITY

3-5-1. Introduction

The Realtek ALC655 sound function enhanced in this system is fully compatible with Windows 2000 and Windows XP. Below, you will find the content of the Sound driver :

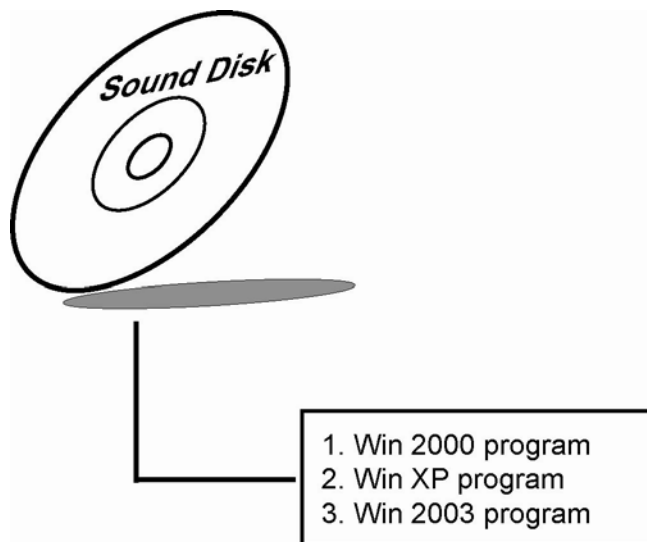

3-5-2. Installation Procedure for Windows 2000/XP/2003

1. From the task bar, click on Start, and then Run.
2. In the Run dialog box, type D:\Sound\path\setup, where "D:\Sound\pathname" refers to the full path to the source files.
3. Click on the OK button or press the ENTER key.
4. Click on the "Next" and OK prompts as they appear.
5. Reboot the system to complete the driver installation.

3-6. INTEL® CHIPSET SOFTWARE INSTALLATION UTILITY

3-6-1. Introduction

The Intel® Chipset Software Installation Utility installs to the target system the Windows* INF files that outline to the operating system how the chipset components will be configured. This is needed for the proper functioning of the following features:

- Core PCI and ISAPNP Services
- AGP Support
- IDE/ATA33/ATA66/ATA100 Storage Support
- USB Support
- Identification of Intel® Chipset Components in Device Manager

3-6-2. Installation of Utility for Windows 2000/XP/2003

The Utility Pack is to be installed only for Windows 2000 and XP program.

It should be installed right after the OS installation, kindly follow the following steps:

1. Place insert the Utility Disk into Floppy Disk Drive A/B or CD ROM drive.
2. Under Windows 2000/XP/2003 system, go to the directory where Utility Disc is located.
3. Click **Setup.exe** file for utility installation.
4. Follow the instructions on the screen to complete the installation.
5. Once installation is completed, shut down the system and restart in order for the changes to take effect.

3-7. USB2.0 SOFTWARE INSTALLATION UTILITY

3-7-1. Installation of Utility for Windows 2000/XP

Intel USB 2.0 Enhanced Host Controller driver can only be used on Windows 2000 and Windows XP on Intel Desktop boards. It should be installed right after the OS installation, kindly follow the following steps:

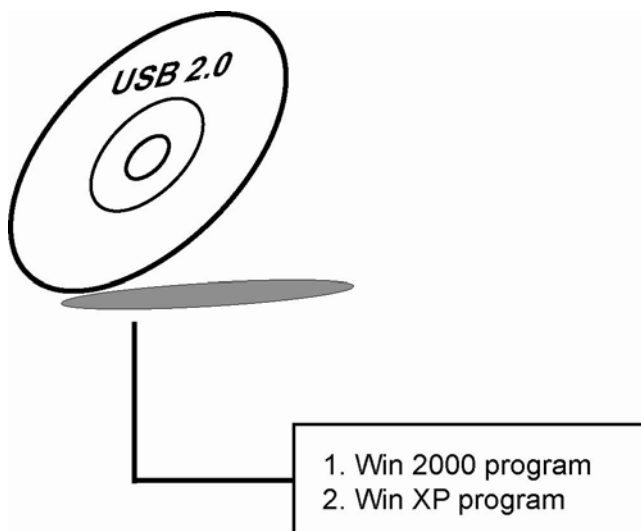

1. Place insert the Utility Disk into Floppy Disk Drive A/B or CD ROM drive.
2. Under Windows 2000, and XP system, go to the directory where Utility Disc is located.
3. Start the "System" wizard in control panel. (Click Start/Settings/Control Panel).
4. Select "Hardware" and click "Device Manager" button.
5. Double Click "USB Root Hub".
6. Select "Driver".
7. Click "Install" to install the driver.
8. Follow the instructions on the screen to complete the installation.
9. Click "Finish" after the driver installation is complete.

3-8. RAID SOFTWARE INSTALLATION UTILITY

3-8-1. Installation of Utility for Windows 2000/2003/XP

The RAID controller management can be used on windows 2000 and windows 2003 and windows XP. It should be installed right after the OS installation.

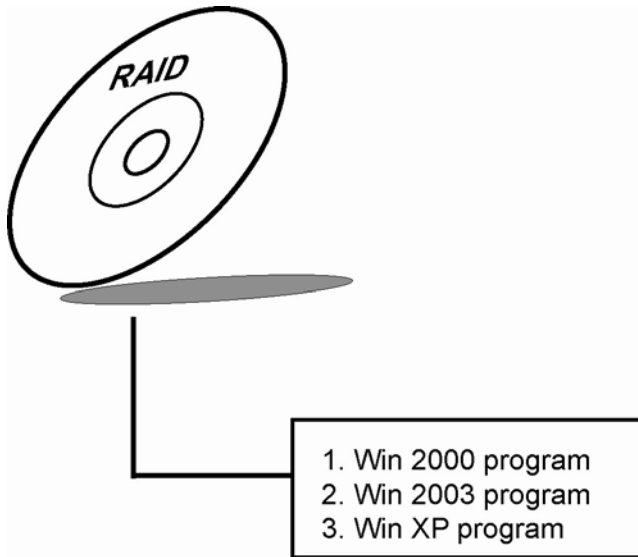

For more details on Installation procedure, please refer to Readme.txt file found on RAID DRIVER UTILITY.

3-9. WATCHDOG TIMER CONFIGURATION

The Watch-dog Timer has a programmable time-out ranging from 1 to 255 minutes with one minute resolution, or 1 to 255 seconds with 1 second resolution. The units of the WDT timeout value are selected via bit[7] of the WDT_TIMEOUT register, which is located on I/O Port address 0x865h. The WDT time-out value is set through the WDT_VAL Runtime register, which is located on I/O Port address 0x866h. Setting the WDT_VAL register to 0x00 disables the WDT function. Setting the WDT_VAL to any other non-zero value will cause the WDT to reload and begin counting down from the value loaded. Setting the Register located on I/O address 0x867h and 0x868h as 00h to finish timer configuration.

Example Code

(1)

```
;-----  
Enable Watch-Dog Timer  
;-----  
    mov dx,(800h + 65h)    ;Time counting Unit minute or second  
    mov al,80h            ;al = 00h : unit minute  
                          ;al = 80h : unit second  
  
    out dx,al  
  
    mov dx,(800h + 66h) ;  
    mov al,20            ;al = Watch dog Timer Second(s), 20 sec(s)  
    out dx,al  
  
    mov dx,(800h + 67h)  
    mov al,00h  
    out dx,al  
  
    mov dx,(800h + 68h)    ;Start Watch Dog Timer  
    mov al,00h  
    out dx,al
```

(2)

```
;-----  
Disable Watch-Dog Timer  
;-----  
    mov dx,(800h + 66h)    ;Disable Watch Dog Timer
```

```
mov al,00h  
out dx,al
```

```
mov dx,(800h + 67h)  
mov al,00h  
out dx,al
```

```
mov dx,(800h + 68h)      ;Clear Status Bit  
mov al,00h  
out dx,al
```

AWARD BIOS SETUP

CHAPTER

4

This chapter shows how to set up the Award BIOS.

Section includes:

- Introduction
- Entering Setup
- The Standard CMOS Features
- The Advanced BIOS Features
- The Advanced Chipset Features
- Integrated Peripherals
- Power Management Setup
- PNP/PCI Configuration
- PC Health Status
- Load Fail-Safe Defaults
- Load Optimized Defaults
- Password Setting
- Save and Exit Setup
- Exit Without Saving

4-1. INTRODUCTION

This chapter will show you the function of the BIOS in managing the features of your system. The PMB-531LF Intel Core Duo/Solo ATX Motherboard is equipped with the BIOS for system chipset from Phoenix - Award Software Inc. This page briefly explains the function of the BIOS in managing the special features of your system. The following pages describe how to use the BIOS for system chipset Setup menu.

Your application programs (such as word processing, spreadsheets, and games) rely on an operating system such as DOS or OS/2 to manage such things as keyboard, monitor, disk drives, and memory.

The operating system relies on the BIOS (Basic Input and Output system), a program stored on a ROM (Read-only Memory) chip, to initialize and configure your computer's hardware. As the interface between the hardware and the operating system, the BIOS enables you to make basic changes to your system's hardware without having to write a new operating system.

The following diagram illustrates the interlocking relationships between the system hardware, BIOS, operating system, and application program:

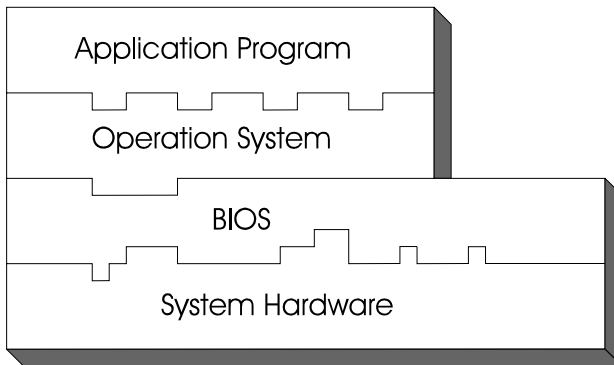

4-2. ENTERING SETUP

When the system is powered on, the BIOS will enter the Power-On Self Test (POST) routines and the following message will appear on the lower screen:

PRESS TO ENTER SETUP, ESC TO SKIP MEMORY TEST

As long as this message is present on the screen you may press the key (the one that shares the decimal point at the bottom of the number keypad) to access the Setup program. In a moment, the main menu of the Award SETUP program will appear on the screen:

Phoenix - AwardBIOS CMOS Setup Utility

▶ Standard CMOS Features	Load Fail-Safe Defaults
▶ Advanced BIOS Features	Load Optimized Defaults
▶ Advanced Chipset Features	Set Supervisor Password
▶ Integrated Peripherals	Set User Password
▶ Power Management Setup	Save & Exit Setup
▶ PnP/PCI Configurations	Exit Without Saving
▶ PC Health Status	
Esc : Quit	↑↓→← : Select Item
F10 : Save & Exit Setup	
Time, Date, Hard Disk Type	

Setup program initial screen

You may use the cursor the up/down keys to highlight the individual menu items. As you highlight each item, a brief description of the highlighted selection will appear at the bottom of the screen.

4-3. THE STANDARD CMOS FEATURES

Highlight the "STANDARD CMOS FEATURES" and press the <ENTER> key and the screen will display the following table:

Phoenix - AwardBIOS CMOS Setup Utility
Standard CMOS Features

Date (mm:dd:yy)	Sun, Feb 2 2003	Item Help
Time (hh:mm:ss)	21 : 3 : 7	
▶ IDE Channel 0 Master	[ST320014A]	Menu Level ▶ Change the day, month, year and century
▶ IDE Channel 0 Slave	[None]	
▶ IDE Channel 1 Master	[None]	
▶ IDE Channel 1 Slave	[None]	
▶ IDE Channel 2 Master	[HDS728080PLA380]	
▶ IDE Channel 2 Slave	[HDS728080PLA380]	
▶ IDE Channel 3 Master	[HDS728080PLA380]	
▶ IDE Channel 3 Slave	[HDS728080PLA380]	
Video	[EGA/VGA]	
Halt On	[All Errors]	
Base Memory	640K	
Extended Memory	2006912K	
Total Memory	2087936K	
↑↓→←: Move Enter: Select +/-/PU/PD:Value F10:Save ESC:Exit F1:General Help F5: Previous Values F6: Fail-Safe Defaults F7:Optimized Defaults		

CMOS Setup screen

In the above Setup Menu, use the arrow keys to highlight the item and then use the <PgUp> or <PgDn> keys to select the value you want in each item.

Date:

< Month >, < Date > and <Year >. Ranges for each value are in the CMOS Setup Screen, and the week-day will skip automatically.

Time:

< Hour >, < Minute >, and < Second >. Use 24 hour clock format, i.e., for PM numbers, add 12 to the hour. For example: 4: 30 P.M. You should enter the time as 16:30:00.

IDE Primary Master / Slave:

IDE Secondary Master / Slave:

The BIOS can automatically detect the specifications and optimal operating mode of almost all IDE hard drives. When you select type AUTO for a hard drive, the BIOS detect its specifications during POST, every time system boots.

If you do not want to select drive type AUTO, other methods of selecting drive type are available:

1. Match the specifications of your installed IDE hard drive(s) with the preprogrammed values for hard drive types 1 through 45.
2. Select USER and enter values into each drive parameter field.
3. Use the IDE HDD AUTO DETECTION function in Setup.

Here is a brief explanation of drive specifications:

Type: The BIOS contains a table of pre-defined drive types. Each defined drive type has a specified number of cylinders, number of heads, write precompensation factor, landing zone, and number of sectors. Drives whose specifications do not accommodate any predefine type are classified as type USER.

- Size: Disk drive capacity (approximate). Note that this size is usually greater than the size of a formatted disk given by a disk-checking program.
- Cyls: number of cylinders.
- Head: number of heads.
- Precomp: write precompensation cylinders.
- Landz: landing zone.
- Sector: number of sectors.
- Mode: Auto, Normal, Large or LBA.

Auto: The BIOS automatically determines the optimal mode.

- Normal: Maximum number of cylinders, heads, sectors supported are 1024, 16 and 63.
- Large: For drives that do not support LBA and have more than 1024 cylinders.
- LBA (Logical Block Addressing): During drive accesses, the IDE controller transforms the data address described by sector, head and cylinder number into a physical block address, significantly improving data transfer rates. For drives greater than 1024 cylinders.

VIDEO:

This category selects the type of video adapter used for the primary system monitor. Although secondary monitors are supported, you do not have to select the type in Setup. Available Options are as follows:

EGA/VGA	Enhanced Graphics Adapter/Video Graphics Array. For EGA, VGA, SEGA, SVGA or PGA monitor adapters.
CGA 40	Color Graphics Adapter, power up in 40 column mode.
CGA 80	Color Graphics Adapter, power up in 80 column mode.
MONO	Monochrome adapter, includes high resolution monochrome adapters.

HALT ON:

This category allows user to choose whether the computer will stop if an error is detected during power up. Available options are “All errors”, “No errors”, “All, But keyboard”, “All, But Diskette”, and “All But Disk/Key”.

BASE MEMORY:

Displays the amount of conventional memory detected during boot up.

EXTENDED MEMORY:

Displays the amount of extended memory detected during boot up.

TOTAL MEMORY:

Displays the total memory available in the system.

HARD DISK ATTRIBUTES:

Type	Cylinders	Heads	V-P comp	LZone	Sect	Capacity
1	306	4	128	305	17	10
2	615	4	300	615	17	20
3	615	6	300	615	17	30
4	940	8	512	940	17	62
5	940	6	512	940	17	46
6	615	4	65535	615	17	20
7	642	8	256	511	17	30
8	733	5	65535	733	17	30
9	900	15	65535	901	17	112
10	820	3	65535	820	17	20
11	855	5	65535	855	17	35
12	855	7	65535	855	17	49
13	306	8	128	319	17	20
14	733	7	65535	733	17	42
15	000	0	0000	000	00	00
16	612	4	0000	663	17	20
17	977	5	300	977	17	40
18	977	7	65535	977	17	56
19	1024	7	512	1023	17	59
20	733	5	300	732	17	30
21	733	7	300	732	17	42
22	733	5	300	733	17	30
23	306	4	0000	336	17	10
24	977	5	65535	976	17	40
25	1024	9	65535	1023	17	76
26	1224	7	65535	1223	17	71
27	1224	11	65535	1223	17	111
28	1224	15	65535	1223	17	152
29	1024	8	65535	1023	17	68
30	1024	11	65535	1023	17	93
31	918	11	65535	1023	17	83
32	925	9	65535	926	17	69
33	1024	10	65535	1023	17	85
34	1024	12	65535	1023	17	102
35	1024	13	65535	1023	17	110
36	1024	14	65535	1023	17	119
37	1024	2	65535	1023	17	17
38	1024	16	65535	1023	17	136
39	918	15	65535	1023	17	114
40	820	6	65535	820	17	40
41	1024	5	65535	1023	17	42
42	1024	5	65535	1023	26	65
43	809	6	65535	852	17	40
44	809	6	65535	852	26	61
45	776	8	65335	775	33	100
47			AUTO			

Award Hard Disk Type Table

4-4. THE ADVANCED BIOS FEATURES

Choose the “ADVANCED BIOS FEATURES” in the main menu, the screen shown as below.

Phoenix - AwardBIOS CMOS Setup Utility
Advanced BIOS Features

▶ CPU Feature	[Press Enter]	Item Help
▶ Hard Disk Boot Priority	[Press Enter]	
First Boot Device	[CDROM]	Menu Level ▶
Second Boot Device	[Hard Disk]	
Third Boot Device	[LS120]	
Boot Other Device	[Enabled]	
Security Option	[Setup]	
APIC Mode	[Enabled]	
MPS Version Control For OS	[1.4]	
↑↓→←: Move Enter: Select +/-/PU/PD:Value F10:Save ESC:Exit F1:General Help F5: Previous Values F6: Fail-Safe Defaults F7:Optimized Defaults		

BIOS Features Setup Screen

The “BIOS FEATURES SETUP” allow you to configure your system for basic operation. The user can select the system’s boot-up sequence and security.

A brief introduction of each setting is given below.

CPU FEATURE:

The options for these items are found in its sub menu. By pressing the <ENTER> key, you are prompt to enter the sub menu of the detailed options as shown below:

Phoenix – Award CMOS Setup Utility
CPU Feature

Delay Prior to Thermal	[16 Min]	Item Help
Thermal Management	[Thermal Monitor 1]	
X TM2 Bus Ratio	12X	Menu Level ►
X TM2 Bus VID	1.404V	
C1E Function	[Auto]	
Execute Disable Bit	[Enabled]	
↑↓→←:Move Enter: Select +/-/PU/PD:Value F10:Save ESC:Exit F1:General Help F5: Previous Values F6:Fail-Safe Defaults F7:Optimized Defaults		

Descriptions on each item above are as follows:

1. Delay Prior to Thermal

The Delay Prior To Thermal BIOS feature controls the activation of the Thermal Monitor's automatic mode. It allows you to determine when the Pentium-M's Thermal Monitor should be activated in automatic mode after the system boots.

2. Thermal Management

The used Thermal Monitor

3. C1E Function

This is enabled to reduce power during idle operation

4. Execute Disable Bit

To select enable or disable the No-Execution Page Protection Technology.

HARD DISK BOOT PRIORITY:

The options for these items are found in its sub menu. By pressing the <ENTER> key, you are prompt to enter the sub menu of the detailed options as shown below:

Phoenix – Award CMOS Setup Utility
Hard Disk Boot Priority

<ol style="list-style-type: none"> 1. Ch0 M. : ST320014A 2. CH2 M. : HDS728080PLA380 3. CH3 M. : HDS728080PLA380 4. CH2 S. : HDS728080PLA380 5. CH3 S. : HDS728080PLA380 6. Bootable Add-in Cards 	<p>Item Help</p> <hr/> <p>Menu Level ►</p> <p>Use<↑> or <↓> to select a device, then press <+> to move it up, or <-> to move it down the list. Press <ESC> to exit this menu.</p>
<p>↑↓→←:Move Enter: Select +/-/PU/PD:Value F10:Save ESC:Exit F1:General Help F5: Previous Values F6:Fail-Safe Defaults F7:Optimized Defaults</p>	

Select Hard Disk Boot Device Priority

FIRST/SECOND/ THIRD/ OTHER BOOT DEVICE:

The BIOS attempt to load the operating system from the devices in the sequence selected in these items.

SECURITY OPTION:

This category allows you to limit access to the system and Setup, or just to Setup.

System	The system will not boot and access to Setup will be denied if the correct password is not entered at the prompt.
Setup	The system will boot, but access to Setup will be denied if the correct password is not entered at the prompt.

🔔 To disable security, select PASSWORD SETTING at Main Menu and then you will be asked to enter password. Do not type anything and just press <Enter>, it will disable security. Once the security is disabled, the system will boot and you can enter Setup freely.

APIC MODE:

To Enable Advanced Programmable Interrupt Controller

MPS VERSION CONTROL FOR OS:

This option is only valid for multiprocessor motherboards as it specifies the version of the Multiprocessor Specification (MPS) that the motherboard will use. The MPS is a specification by which PC manufacturers design and build Intel architecture systems with two or more processors.

4-5. ADVANCED CHIPSET FEATURES

Choose the "ADVANCED CHIPSET FEATURES" from the main menu, the screen shown as below.

Phoenix - AwardBIOS CMOS Setup Utility
Advanced Chipset Features

DRAM Timing Selectable	[By SPD]	Item Help
X CAS Latency Time	[Auto]	
X DRAM RAS# to CAS# Delay	[Auto]	
X DRAM RAS# Precharge	[Auto]	Menu Level ▶
X Precharge dealy (tRAS)	[Auto]	
System Memory Frequency	[Auto]	
System BIOS Cacheable	[Enabled]	
Video BIOS Cacheable	[Disabled]	
Memory Hole At 15M-16M	[Disabled]	
** VGA Setting **		
PEG/Onchip VGA Control	[Auto]	
On-Chip Frame Buffer Size	[8MB]	
DVMT Mode	[DVMT]	
DVMT/ FIXED Memory Size	[128 MB]	
Boot Display	[CRT]	
Panel Type	[640x480 18-bit]	
TV Format	[Auto]	
PCI SERR# NMI	[Disabled]	
↑↓→←: Move Enter: Select +/-/PU/PD:Value F10:Save ESC:Exit F1:General Help F5: Previous Values F6: Fail-Safe Defaults F7:Optimized Defaults		

Chipset Features Setup Screen

This parameter allows you to configure the system based on the specific features of the installed chipset. The chipset manages bus speed and access to system memory resources, such as DRAM and the external cache.

It also coordinates communications between conventional ISA bus and the PCI bus. It must be stated that these items should never need to be altered. The default settings have been chosen because they provide the best operating conditions for the system. The only time you might consider making any changes would be if you discovered that data was being lost while using your system.

DRAM TIMEING SELECTABLE:

The value in this field depends on performance parameters of the installed memory chips (DRAM). Do not change the value from the factory setting unless you install new memory that has a different performance rating than the original DRAMs.

CAS LATENCY TIME:

When synchronous DRAM is installed, the number of clock cycles of CAS latency depends on the DRAM timing.

DRAM RAS# TO CAS# DELAY:

This item let you insert a timing delay between the CAS and RAS strobe signals, used when DRAM is written to, read from, or refreshed. Fast gives faster performance; and Slow gives more stable performance. This field applies only when synchronous DRAM is installed in the system. The choices are 2 and 3.

DRAM RAS# PRECHARGE TIME:

If an insufficient number of cycles is allowed for the RAS to accumulate its charge before DRAM refresh, the refresh may be incomplete and the DRAM may fail to retain data. Fast gives faster performance; and Slow gives more stable performance. This field applies only when synchronous DRAM is installed in the system. The choices are 2 & 3.

PRECHARGE DEALY (tRAS):

Precharge Delay This setting controls the precharge delay, which determines the timing delay for DRAM precharge

System Memory Frequency:

Allow to choose different frequency of memory module.

SYSTEM BIOS CACHEABLE:

Selecting Enabled allows caching of the system BIOS ROM at F0000h-FFFFFh, resulting in better system performance. However, if any program writes to this memory area, a system error may result.

VIDEO BIOS CACHEABLE:

Select Enabled allows caching of the video BIOS, resulting in better system performance. However, if any program writes to this memory area, a system error may result.

MEMORY HOLE AT 15-16M:

You can reserve this area of system memory for ISA adapter ROM. When this area is reserved, it cannot be cached. The user information of peripherals that need to use this area of system memory usually discusses their memory requirements

PEG/ONCHIP VGA CONTROL:

To select the PCI-Express Graphics or onchip VGA Graphics.

ON-CHIP FRAME BUFFER SIZE:

The On-Chip Frame Buffer Size can be set as 32MB. This memory is shared with the system memory.

DVMT MODE:

Intel Dynamic Video Memory Technology Mode.

DVMT/FIXED MEMORY SIZE:

DVMT Memory Size Select.

BOOT DISPLAY:

To select the boot-up display type.

Panel Type:

This field allows user to decide the LVDS panel resolution

TV FORMAT:

To select TV-Format type

PCI SERR# NMI:

To Enable/Disable the PCI SERR# interrupt

4-6. INTEGRATED PERIPHERALS

Choose "INTEGRATED PERIPHERALS" from the main setup menu, a display will be shown on screen as below:

Phoenix - AwardBIOS CMOS Setup Utility
Integrated Peripherals

▶ OnChip IDE Device	[Press Enter]	Item Help
▶ Onboard Device	[Press Enter]	
▶ SuperIO Device	[Press Enter]	Menu Level ▶
Onboard Serial Port 3	[3E8/IRQ10]	
Onboard Serial Port 4	[2E8/IRQ11]	
WatchDog Support	[Disabled]	
↑↓→←: Move Enter: Select +/-/PU/PD:Value F10:Save ESC:Exit F1:General Help F5: Previous Values F6: Fail-Safe Defaults F7:Optimized Defaults		

Integrated Peripherals Setup Screen

By moving the cursor to the desired selection and by pressing the <F1> key, the all options for the desired selection will be displayed for choice.

- 🔔 If bios setup menu item supports USB device boot, it will cause Win9x detects the same storages twice when the system is rebooted, and USB HDD will fail. Note: this cause just happen under Win9x, the phenomenon is a limitation.

ONCHIP IDE DEVICE:

The options for these items are found in its sub menu. By pressing the <ENTER> key, you are prompt to enter the sub menu of the detailed options as shown below:

Phoenix – Award CMOS Setup Utility
OnChip IDE Device

IDE HDD Block Mode	[Enabled]	Item Help
IDE DMA transfer access	[Enabled]	Menu Level ► If your IDE hard drive supports block mode select Enabled for automatic detection of the optional number of block read/writes per sector the drive can support.
OnChip Primary PCI IDE	[Enabled]	
IDE Primary Master PIO	[Auto]	
IDE Primary Slave PIO	[Auto]	
IDE Primary Master UDMA	[Auto]	
IDE Primary Slave UDMA	[Auto]	
OnChip Secondary PCI IDE	[Enabled]	
IDE Secondary Master PIO	[Auto]	
IDE Secondary Slave PIO	[Auto]	
IDE Secondary Master UDMA	[Auto]	
IDE Secondary Slave UDMA	[Auto]	
*** On-Chip Serial ATA Setting ***		
SATA Mode	[IDE]	
On-Chip Serial ATA	[Auto]	
X PATA IDE Mode	Primary	
SATA Port	P1, P3 is Secondary	
↑↓→←:Move Enter: Select +/-/PU/PD:Value F10:Save ESC:Exit F1:General Help F5: Previous Values F6:Fail-Safe Defaults F7:Optimized Defaults		

Descriptions on each item above are as follows:

1. IDE HDD Block Mode

Block mode is also called block transfer, multiple commands, or multiple sector read/write. If your IDE hard drive supports block mode (most new drives do), select Enabled for automatic detection of the optimal number of block read/writes per sector the drive can support

2. IDE DMA Transfer Access

To Enable/Disable the IDE DMA transfer access

3. OnChip Primary PCI IDE

The integrated peripheral controller contains an IDE interface with support for two IDE channels. Select Enabled to activate each channel separately.

4. Primary Master/Slave PIO

Secondary Master/Slave PIO

The four IDE PIO fields allow you to set a PIO mode (0-4) for each of the four IDE devices that the onboard IDE interface supports. Modes 0 through 4 provide successively increased performance. In Auto mode, the system automatically determines the best mode for each device.

5. SATA Mode:

Set the Serial ATA configuration. When set in Advanced Host Controller Interface (AHCI) or RAID mode, the SATA controller is set to Native mode. Configuration options: [IDE] [RAID] [AHCI].

6. Primary Master/Slave UDMA

Secondary Master/Slave UDMA

Ultra DMA/33 implementation is possible only if your IDE hard drive supports it and the operating environment includes a DMA driver (Windows 95 OSR2 or a third-party IDE bus master driver). If you hard drive and your system software both support Ultra DMA/33, select Auto to enable BIOS support.

7. On-Chip Serial ATA:

[Disabled]: Disabled SATA Controller.

[Auto]: Auto arrange by BIOS.

[Combined Mode]: PATA and SATA are combined. Max.of 2 IDE drives in each channel.

[Enhanced Mode]: Enable both SATA and PATA. Max.of 6 IDE drives are supported.

[SATA Only]: SATA is operating in legacy mode.

8. PATA IDE Mode

To select PATA IDE Mode sequence

9. SATA Port

According PATA IDE Mode to determine SATA sequence

ONBOARD DEVICE:

The options for these items are found in its sub menu. By pressing the <ENTER> key, you are prompt to enter the sub menu of the detailed options as shown below:

Phoenix – Award CMOS Setup Utility
Onboard Device

USB Controller	[Enabled]	Item Help
USB 2.0 Controller	[Enabled]	
USB Keyboard Support	[Enabled]	
		Menu Level ►
↑↓→←:Move Enter: Select +/-/PU/PD:Value F10:Save ESC:Exit F1:General Help F5: Previous Values F6:Fail-Safe Defaults F7:Optimized Defaults		

Descriptions on each item above are as follows:

1. USB Controller

This should be enabled if your system has a USB installed on the system board and you want to use it. Even when so equipped, if you add a higher performance controller, you will need to disable this feature.

2. USB 2.0 Controller

Enable the USB 2.0 controller

3. USB Keyboard Support

Select Enabled if your system contains a Universal Serial Bus (USB) controller and you have a USB keyboard.

SUPER IO DEVICE:

The options for these items are found in its sub menu. By pressing the <ENTER> key, you are prompt to enter the sub menu of the detailed options as shown below:

Phoenix – Award CMOS Setup Utility
SuperIO Device

Onboard Serial Port 1	[3F8/IRQ4]	Item Help
Onboard Serial Port 2	[2F8/IRQ3]	
UART Mode Select	[Normal]	Menu Level ►
TxD, RxD Polarity Active	[Lo, Hi]	
↑↓→←:Move Enter: Select +/-/PU/PD:Value F10:Save ESC:Exit F1:General Help F5: Previous Values F6:Fail-Safe Defaults F7:Optimized Defaults		

Descriptions on each item above are as follows:

- 1. Onboard Serial Port 1/2**
Select an address and corresponding interrupt for the first and second serial ports.
- 2. UART Mode Select**
This item allows you to select UART mode.
- 3. TxD, RxD Polarity Active**
This item allows you to determine the active of RxD, TxD

**ONBOARD SERIAL PORT 3:
ONBOARD SERIAL PORT 4:**

Select a logical COM port name and matching address for the third and forth serial ports. Select an address and corresponding interrupt for third and forth serial port.

WATCHDOG SUPPORT:

To select watch-dog times.

4-7. POWER MANAGEMENT SETUP

Choose "POWER MANAGEMENT SETUP" option on the main menu, a display will be shown on screen as below :

Phoenix - AwardBIOS CMOS Setup Utility		
Power Management Setup		
ACPI Function	[Enabled]	Item Help
Video Off In Suspend	[Yes]	
Soft-Off by PWR-BTTN	[Instant-Off]	
PWRON After PWR-Fail	[Off]	
		Menu Level ►
↑↓→←: Move Enter: Select +/-/PU/PD:Value F10:Save ESC:Exit F1:General Help F5: Previous Values F6: Fail-Safe Defaults F7:Optimized Defaults		

Power Management Setup Screen

The "Power Management Setup" allows the user to configure the system to the most effectively save energy while operating in a manner consistent with your own style of computer use.

ACPI FUNCTION:

Users are allowed to enable or disable the Advanced Configuration and Power Management (ACPI).

SOFT-OFF BY PWR-BTTN:

Pressing the power button for more than 4 seconds forces the system to enter the Soft-Off state when the system has "hung". The choices are Delay 4 Sec and Instant-Off.

PWRON AFTER PWR-FAIL:

This item allows you to select if you want to power on the system after power failure. The choice: Off and On

4-8. PNP/PCI CONFIGURATION

Choose "PNP/PCI CONFIGURATION" from the main menu, a display will be shown on screen as below:

Phoenix - AwardBIOS CMOS Setup Utility
PnP/PCI Configurations

Init Display First	[PCI Slot]	Item Help
Reset Configuration Data	[Disabled]	
Resources Controlled By	[Auto (ESCD)]	Menu Level ▶
x IRQ Resources	Press Enter	
↑↓→←: Move Enter: Select +/-/PU/PD:Value F10:Save ESC:Exit F1:General Help F5: Previous Values F6: Fail-Safe Defaults F7:Optimized Defaults		

PNP/PCI Configuration Setup Screen

The PNP/PCI Configuration Setup describes how to configure PCI bus system. PCI, also known as Personal Computer Interconnect, is a system, which allows I/O devices to operate at speeds nearing the speed of the CPU itself uses when communicating with its own special components.

This section covers technical items, which is strongly recommended for experienced users only.

INIT DISPLAY FIRST:

This item allows you to decide to active whether PCI Slot or on-chip VGA first.

RESET CONFIGURATION DATA:

Normally, you leave this field Disabled. Select Enabled to reset Extended System Configuration Data (ESCD) when you exit Setup if you have installed a new add-on and the system configuration has caused such a serious conflict that the operating system cannot boot.

RESOURCE CONTROLLED BY:

The Award Plug and Play Bios can automatically configure all of the booth and Plug and Play-compatible devices. However, this capability means absolutely nothing unless you are using a Plug and Play operating system

such as Windows 95. By choosing “manual”, you are allowed to configure the *IRQ Resources and DMA Resources*.

IRQ RESOURCES:

The options for these items are found in its sub menu. By pressing the <ENTER> key, you are prompt to enter the sub menu of the detailed options as shown below:

Phoenix – Award CMOS Setup Utility
IRQ Resources

IRQ-3 assigned to	[PCI Device]	Item Help
IRQ-4 assigned to	[PCI Device]	
IRQ-5 assigned to	[PCI Device]	
IRQ-7 assigned to	[PCI Device]	
IRQ-9 assigned to	[PCI Device]	Menu Level ▶
IRQ-10 assigned to	[PCI Device]	Legacy ISA for devices
IRQ-11 assigned to	[PCI Device]	compliant with the original PC
IRQ-12 assigned to	[PCI Device]	AT bus specification, PCI/ISA
IRQ-14 assigned to	[PCI Device]	PnP for devices compliant
IRQ-15 assigned to	[PCI Device]	with the Plug and Play
		standard whether designed for
		PCI or ISA bus architecture
↑↓→←: Move Enter: Select +/-/PU/PD: Value F10: Save ESC: Exit F1: General Help F5: Previous Values F6: Fail-Safe Defaults F7: Optimized Defaults		

Descriptions on each item above are as follows:

1. IRQ-n Assigned to:

You may assign each system interrupt a type, depending on the type of device using the interrupt.

4-9. PC HEALTH STATUS

Choose "PC HEALTH STATUS" from the main menu, a display will be shown on screen as below:

Phoenix - AwardBIOS CMOS Setup Utility
PC Health Status

Shutdown Temperature	[Disabled]	Item Help
Current CPU Temperature	40 C	
Vcore	1.36V	Menu Level ▶
5V	5.01V	
12V	12.35V	
Fan1 Speed	0 RPM	
Fan2 Speed	0 RPM	
↑↓→←: Move Enter: Select +/-/PU/PD:Value F10:Save ESC:Exit F1:General Help F5: Previous Values F6: Fail-Safe Defaults F7:Optimized Defaults		

PC Health Status Setup Screen

The PC Health Status Setup allows you to select whether to choose between monitoring or to ignore the hardware monitoring function of your system.

SHUTDOWN TEMPERATURE:

This item allows you to set up the CPU shutdown Temperature.

CURRENT CPU TEMPERATURE:

This item shows you the current CPU temperature.

VCORE:

This item shows you the current system voltage.

5V / 12V :

Show you the voltage of 5V/12V.

FAN1/FAN2 SPEED:

This item shows you the current CPU/ SYSTEM FAN speed.

4-10. LOAD FAIL-SAFE DEFAULTS

By pressing the <ENTER> key on this item, you get a confirmation dialog box with a message similar to the following:

Load Fail-Safe Defaults (Y/N) ? N

To use the BIOS default values, change the prompt to "Y" and press the <Enter > key. CMOS is loaded automatically when you power up the system.

4-11. LOAD OPTIMIZED DEFAULTS

When you press <Enter> on this category, you get a confirmation dialog box with a message similar to the following:

Load Optimized Defaults (Y/N) ? N

Pressing "Y" loads the default values that are factory setting for optimal performance system operations.

4-12. PASSWORD SETTING

User is allowed to set either supervisor or user password, or both of them. The difference is that the supervisor password can enter and change the options of the setup menus while the user password can enter only but do not have the authority to change the options of the setup menus.

TO SET A PASSWORD

When you select this function, the following message will appear at the center of the screen to assist you in creating a password.

Enter Password:

Type the password up to eight characters in length, and press < Enter >. The password typed now will clear any previously entered password from CMOS memory. You will be asked to confirm the password. Type the password again and press the < Enter > key. You may also press < Esc > to abort the selection and not enter a password.

 User should bear in mind that when a password is set, you will be asked to enter the password everything you enter CMOS setup Menu.

TO DISABLE THE PASSWORD

To disable the password, select this function (do not enter any key when you are prompt to enter a password), and press the <Enter> key and a message will appear at the center of the screen:

PASSWORD DISABLED!!!
Press any key to continue...

Press the < Enter > key again and the password will be disabled. Once the password is disabled, you can enter Setup freely.

4-13. SAVE & EXIT SETUP

After you have completed adjusting all the settings as required, you must remember to save these setting into the CMOS RAM. To save the settings, select “SAVE & EXIT SETUP” and press <Enter>, a display will be shown as follows:

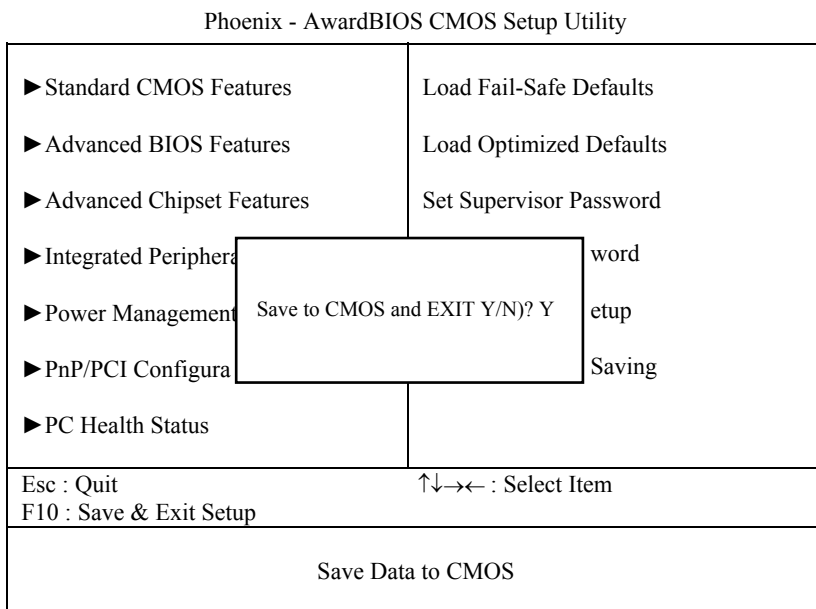

When you confirm that you wish to save the settings, your system will be automatically restarted and the changes you have made will be implemented. You may always call up the setup program at any time to adjust any of the individual items by pressing the key during boot up.

4-14. EXIT WITHOUT SAVING

If you wish to cancel any changes you have made, you may select the “EXIT WITHOUT SAVING” and the original setting stored in the CMOS will be retained. The screen will be shown as below:

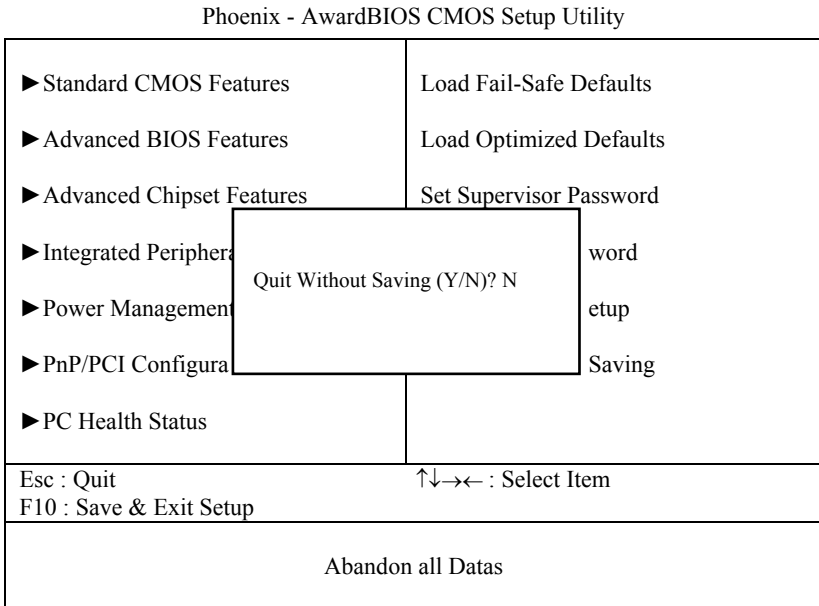

EXPANSION BUS

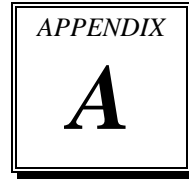

This appendix indicates the pin assignments.

Section includes:

- Mini-PCI BUS Pin Assignment
- Compact Flash Card Connector Pin Assignment

MINI-PCI BUS CONNECTOR PIN ASSIGNMENT

You will find a Mini-PCI connector in our PMB-531LF.
The pin assignments are as follows:

PIN	ASSIGNMENT	PIN	ASSIGNMENT
1	NC	2	NC
3	NC	4	NC
5	NC	6	NC
7	NC	8	NC
9	NC	10	NC
11	NC	12	NC
13	NC	14	NC
15	NC	16	NC
17	PIRQJD	18	VCC
19	VCC3_3	20	PIRQJC
21	NC	22	NC
23	GND	24	VCC3_3SB
25	PPCLK	26	PCI_RSTJ
27	GND	28	VCC3_3
29	PREQJ2	30	PGNTJ2
31	VCC3_3	32	GND
33	AD31	34	PMEJ
35	AD29	36	NC
37	GND	38	AD30
39	AD27	40	VCC3_3
41	AD25	42	AD28
43	NC	44	AD26
45	C_BEJ3	46	AD24
47	AD23	48	IDSEL
49	GND	50	GND
51	AD21	52	AD22
53	AD19	54	AD20
55	GND	56	PAR
57	AD17	58	AD18
59	C_BEJ2	60	AD16
61	IRDYJ	62	GND
63	VCC3_3	64	FRAMEJ
65	NC	66	TRDYJ
67	SERRJ	68	STOPJ
69	GND	70	VCC3_3

71	PERRJ	72	DEVSELJ
73	C_BEJ1	74	GND
75	AD14	76	AD15
77	GND	78	AD13
79	AD12	80	AD11
81	AD10	82	GND
83	GND	84	AD9
85	AD8	86	C_BEJ0
87	AD7	88	VCC3_3
89	VCC3_3	90	AD6
91	AD5	92	AD4
93	NC	94	AD2
95	AD3	96	AD0
97	VCC	98	NC
99	AD1	100	NC
101	GND	102	GND
103	NC	104	NC
105	NC	106	NC
107	NC	108	NC
109	NC	110	NC
111	NC	112	NC
113	NC	114	GND
115	NC	116	NC
117	NC	118	NC
119	NC	120	NC
121	NC	122	NC
123	NC	124	NC

COMPACT FLASH CARD CONNECTOR PIN ASSIGNMENT

The pin assignments of Compact Flash Card connector are stated below.

PIN	ASSIGNMENT	PIN	Assignment
1	GND	26	-CD1
2	D03	27	D11
3	D04	28	D12
4	D05	29	D13
5	D06	30	D14
6	D07	31	D15
7	-CS0	32	-CS1
8	A10	33	-VS1
9	-ATASEL	34	-IORD
10	A09	35	-IOWR
11	A08	36	-WE
12	A07	37	IRQ14
13	VCC	38	VCC
14	A06	39	-CSEL
15	A05	40	-VS2
16	A04	41	-RESET
17	A03	42	IORDY
18	A02	43	-INPACK
19	A01	44	-REG3
20	A00	45	-DASP
21	D00	46	-PDIAG
22	D01	47	D08
23	D02	48	D09
24	-IOCS16	49	D10
25	-CD2	50	GND

TECHNICAL SUMMARY

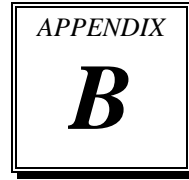

This section introduce you the maps concisely.

Section includes:

- Block Diagram
- Interrupt Map
- RTC & CMOS RAM Map
- Timer & DMA Channels Map
- I / O & Memory Map

BLOCK DIAGRAM

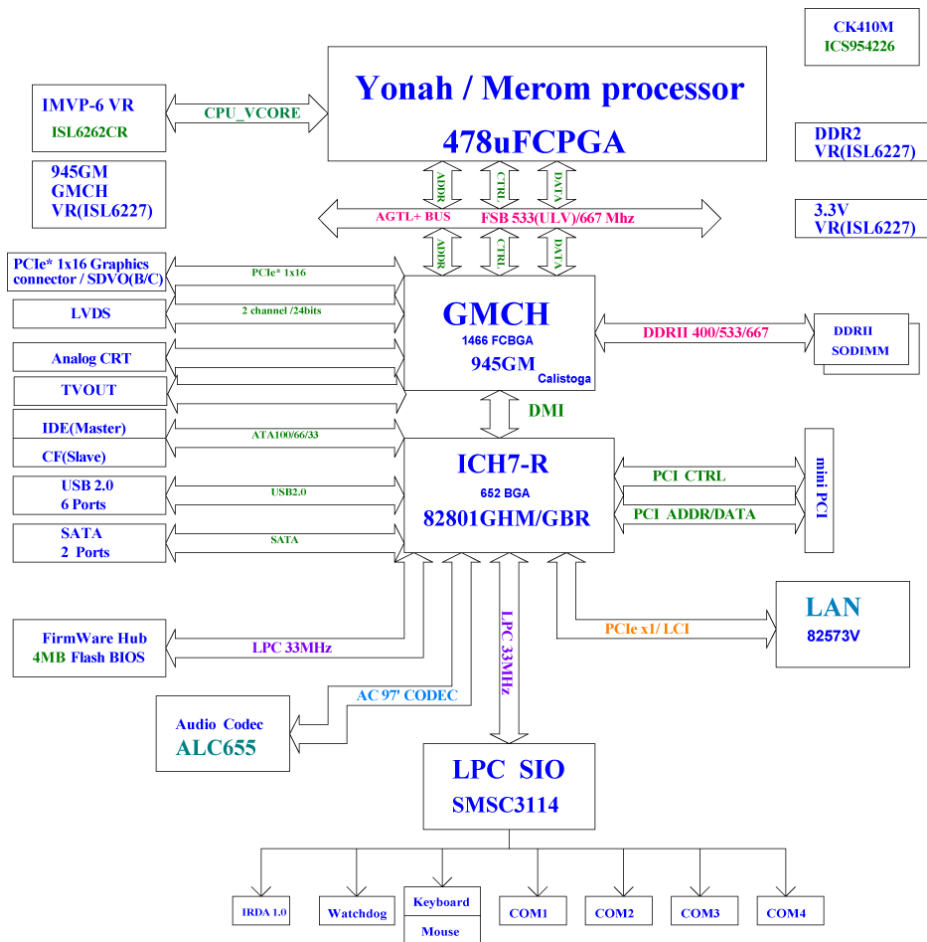

INTERRUPT MAP

IRQ	ASSIGNMENT
0	System TIMER
1	Keyboard
2	Cascade
3	Serial port 2
4	Serial port 1
5	Available
6	Floppy
7	Parallel port 1
8	RTC clock
9	Available
10	Available
11	Available
12	PS/2 Mouse
13	Math coprocessor
14	IDE1
15	IDE2

RTC & CMOS RAM MAP

CODE	ASSIGNMENT
00	Seconds
01	Second alarm
02	Minutes
03	Minutes alarm
04	Hours
05	Hours alarm
06	Day of week
07	Day of month
08	Month
09	Year
0A	Status register A
0B	Status register B
0C	Status register C
0D	Status register D
0E	Diagnostic status byte
0F	Shutdown byte
10	Floppy Disk drive type byte
11	Reserve
12	Hard Disk type byte
13	Reserve
14	Equipment byte
15	Base memory low byte
16	Base memory high byte
17	Extension memory low byte
18	Extension memory high byte
30	Reserved for extension memory low byte
31	Reserved for extension memory high byte
32	Date Century byte
33	Information Flag
34-3F	Reserve
40-7f	Reserved for Chipset Setting Data

TIMER & DMA CHANNELS MAP

Timer Channel Map :

Timer Channel	Assignment
0	System timer interrupt
1	DRAM Refresh request
2	Speaker tone generator

DMA Channel Map :

DMA Channel	Assignment
0	Available
1	Available
2	Floppy
3	Available
4	Cascade
5	Available
6	Available
7	Available

I/O & MEMORY MAP

Memory Map :

MEMORY MAP	ASSIGNMENT
0000000-009FFFF	System memory used by DOS and application
00A0000-00BFFFF	Display buffer memory for VGA/ EGA / CGA / MONOCHROME adapter
00C0000-00DFFFF	Reserved for I/O device BIOS ROM or RAM buffer.
00E0000-00EFFFF	Reserved for PCI device ROM
00F0000-00FFFFFF	System BIOS ROM
0100000-FFFFFFF	System extension memory

I/O Map :

I/O MAP	ASSIGNMENT
000-01F	DMA controller (Master)
020-021	Interrupt controller (Master)
022-023	Chipset controller registers I/O ports.
040-05F	Timer control registers.
060-06F	Keyboard interface controller (8042)
070-07F	RTC ports & CMOS I/O ports
080-09F	DMA register
0A0-0BF	Interrupt controller (Slave)
0C0-0DF	DMA controller (Slave)
0F0-0FF	Math coprocessor
1F0-1F8	Hard Disk controller
278-27F	Parallel port-2
2B0-2DF	Graphics adapter controller
2F8-2FF	Serial port-2
360-36F	Net work ports
378-37F	Parallel port-1
3B0-3BF	Monochrome & Printer adapter
3C0-3CF	EGA adapter
3D0-3DF	CGA adapter
3F0-3F7	Floppy disk controller
3F8-3FF	Serial port-1